

FIG. 1

OVERALL MICROARRAY PROCESS

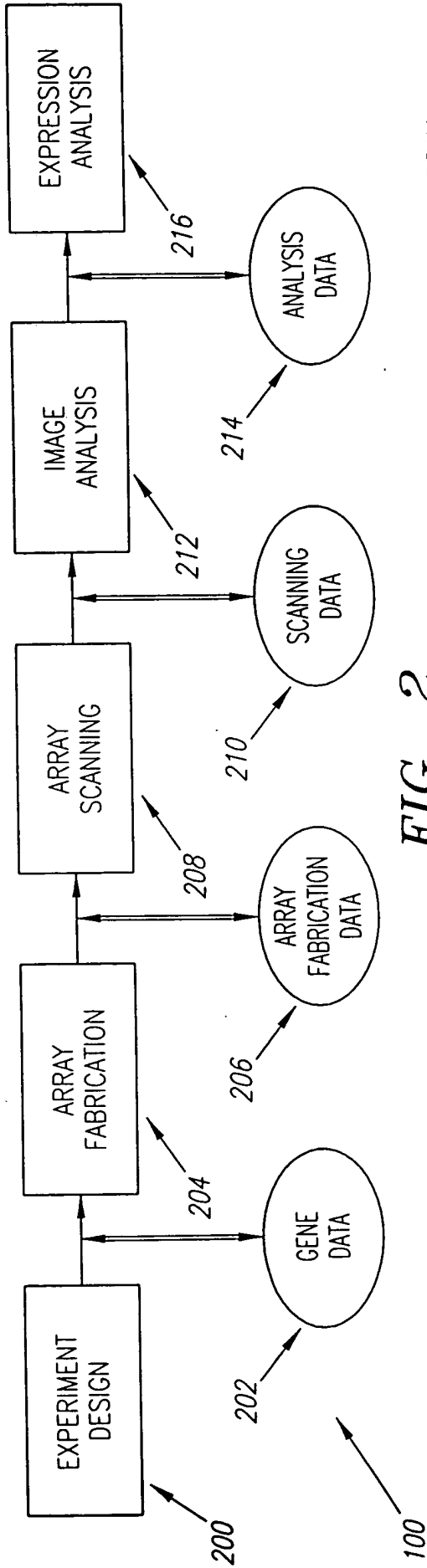

FIG. 2

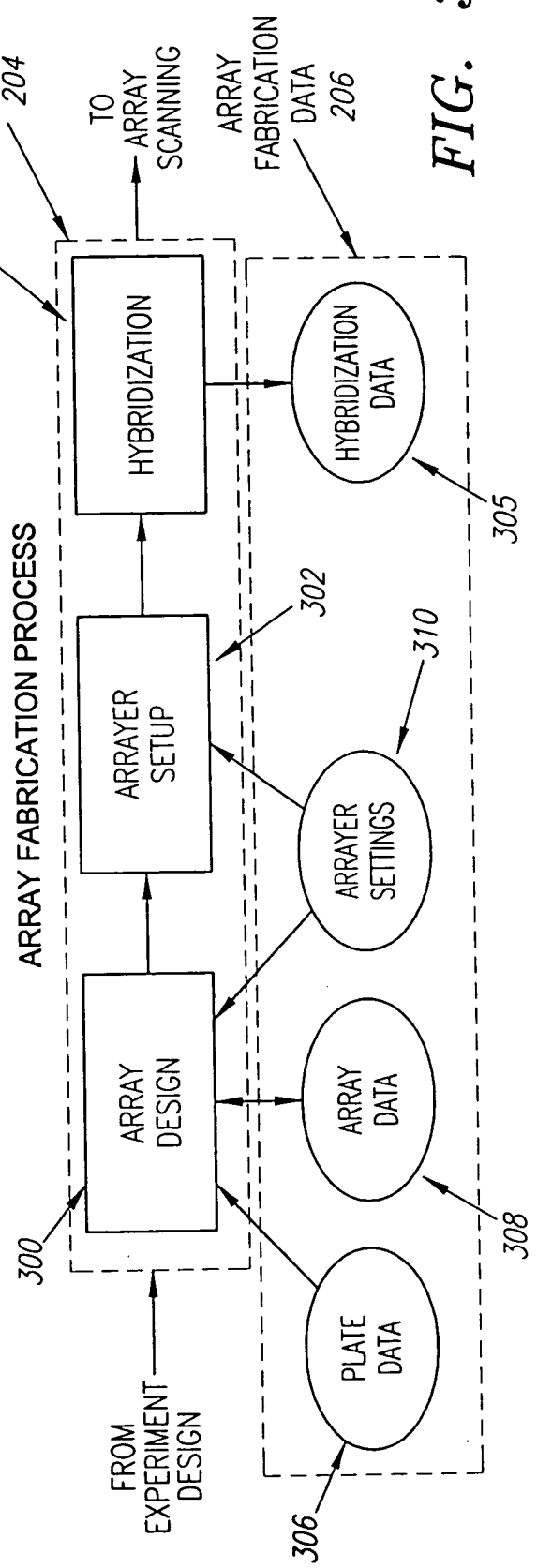
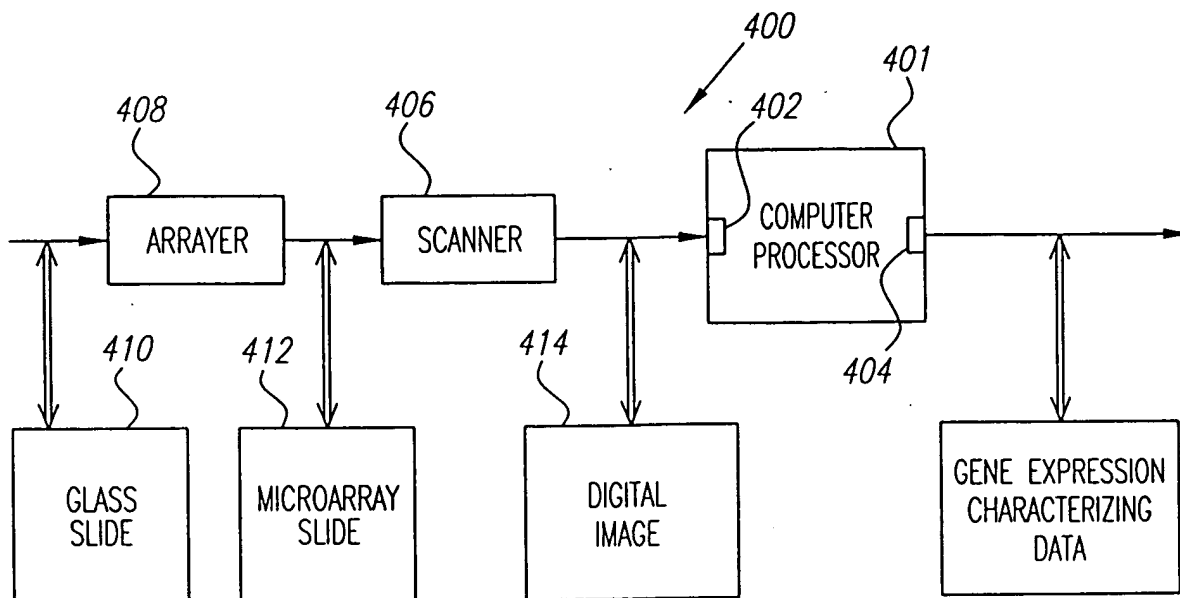
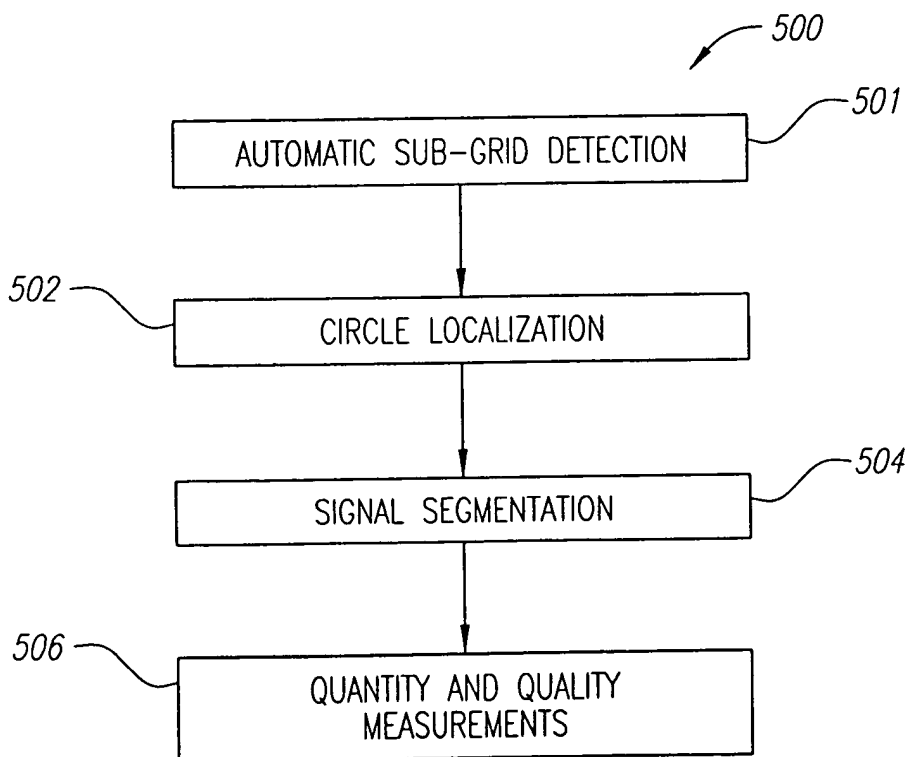
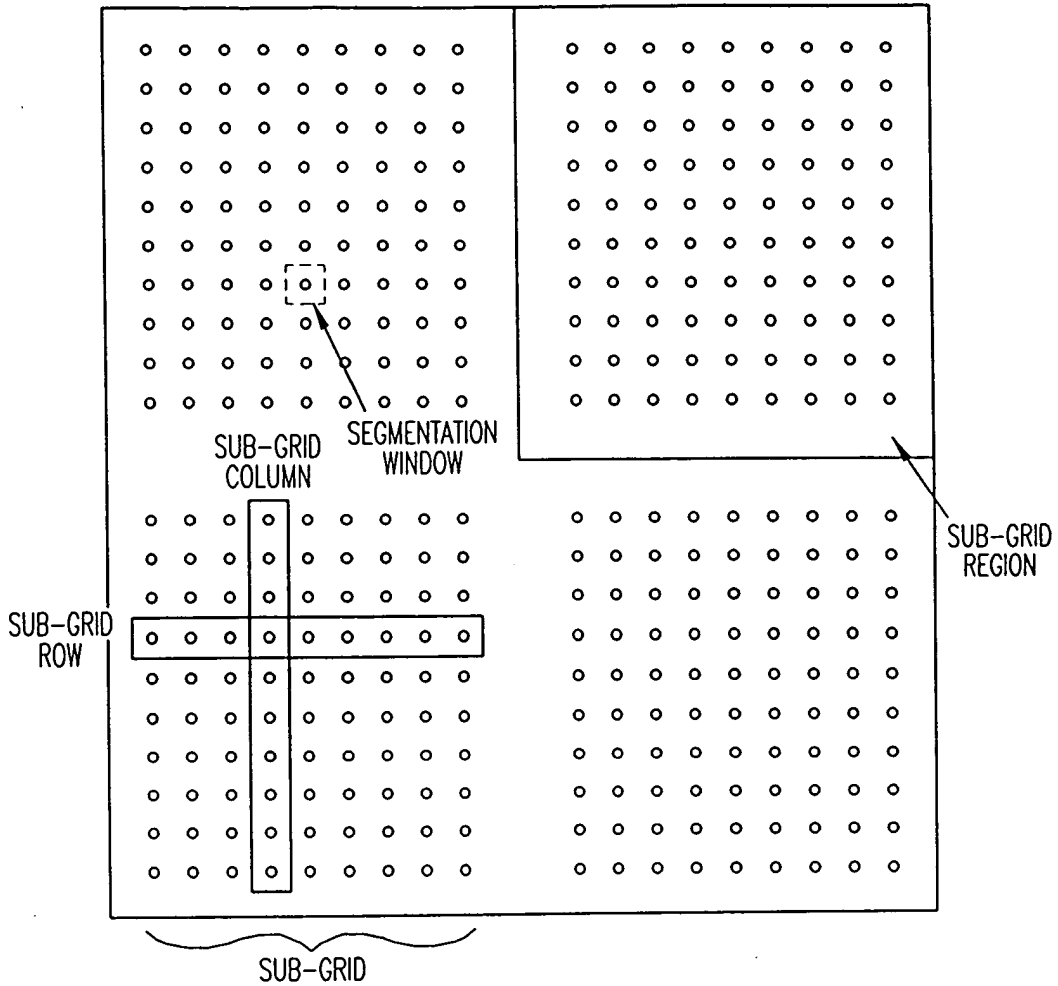

FIG. 3

*FIG. 4**FIG. 5*



2 x 2 MICROARRAY

FIG. 6

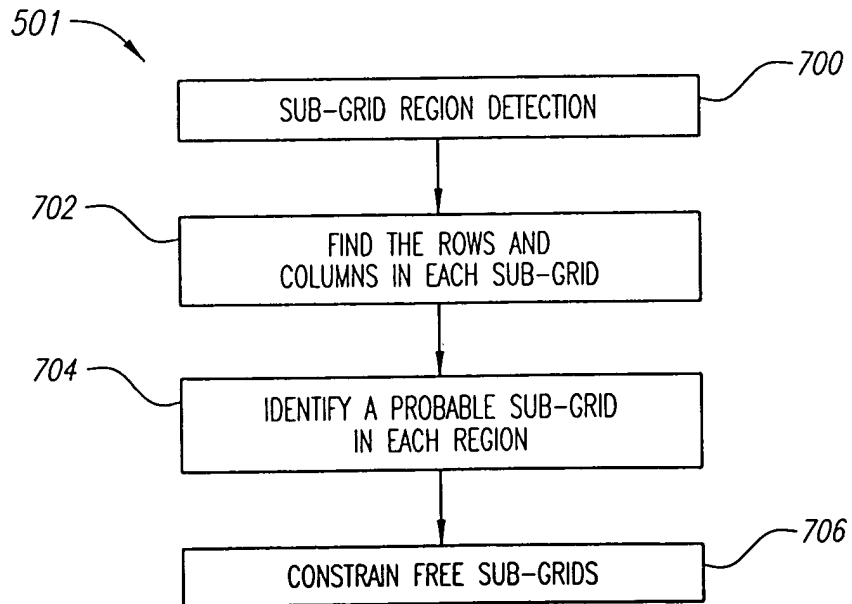

FIG. 7

SUB-GRID REGION DETECTION

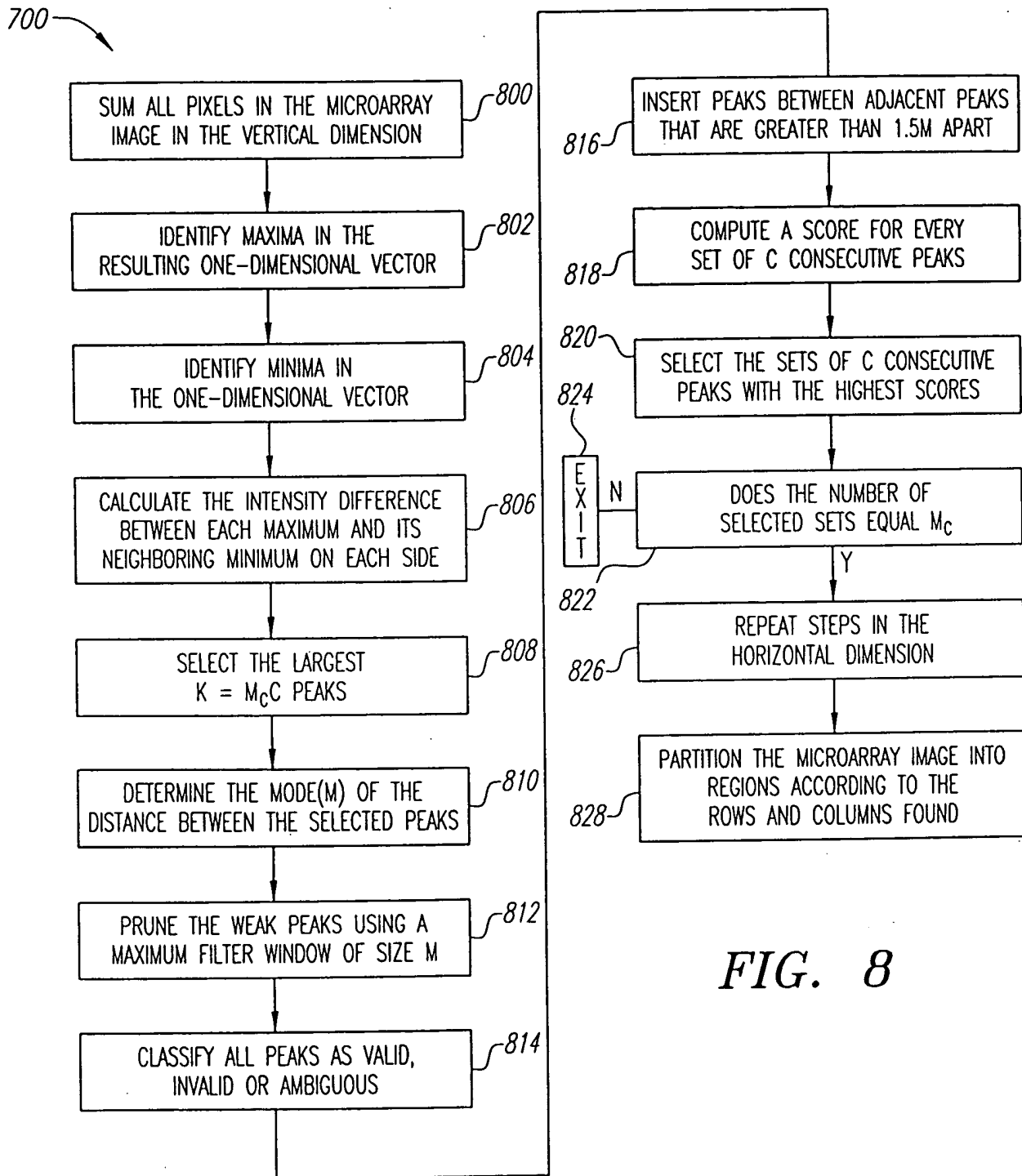

FIG. 8

SUB-GRID ROWS AND COLUMNS DETECTION

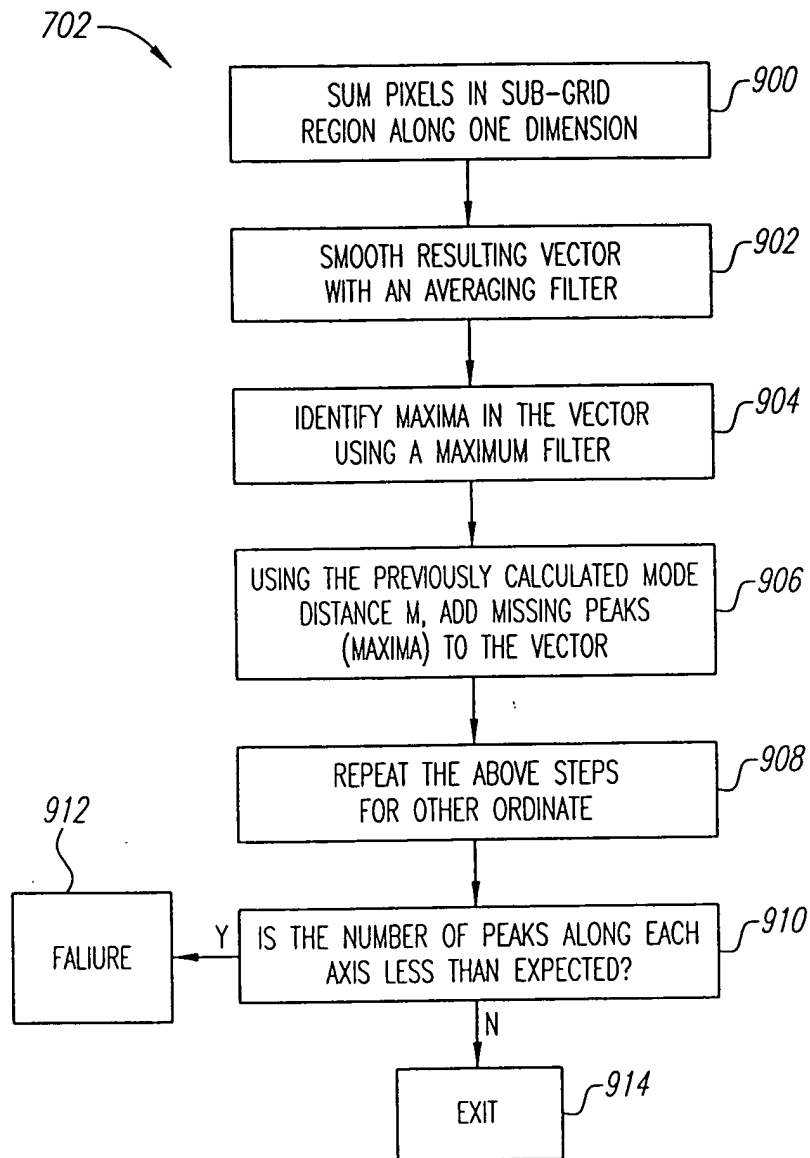

FIG. 9

IDENTIFYING SUB-GRIDS IN EACH SUB-GRID REGION

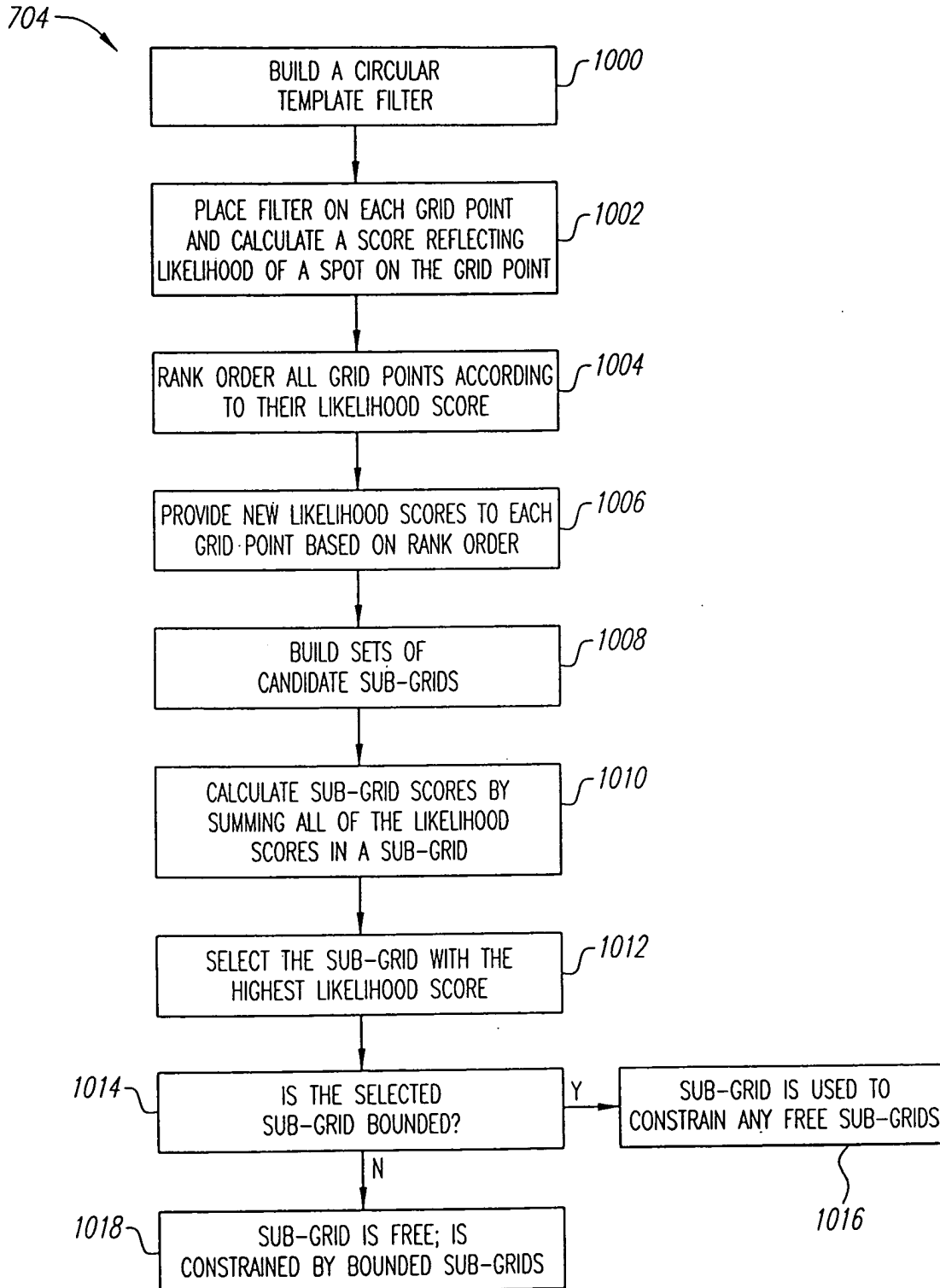

FIG. 10

502

CIRCLE LOCALIZATION

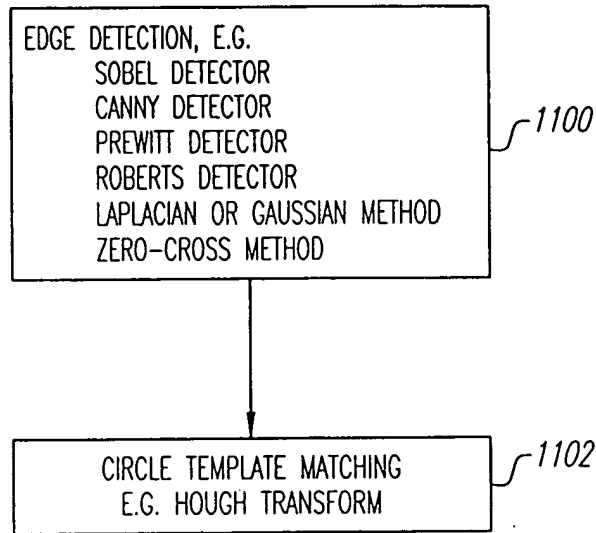
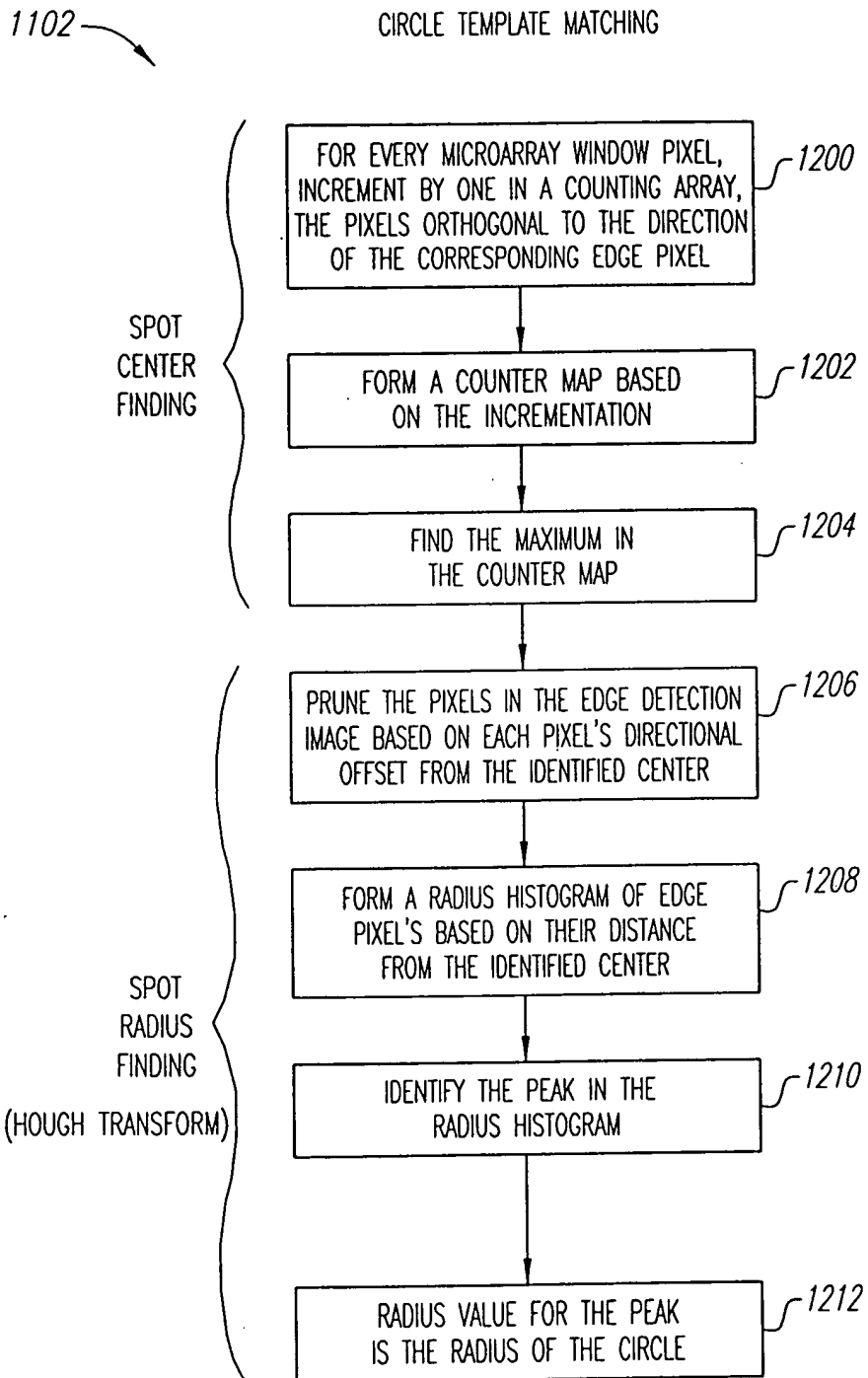
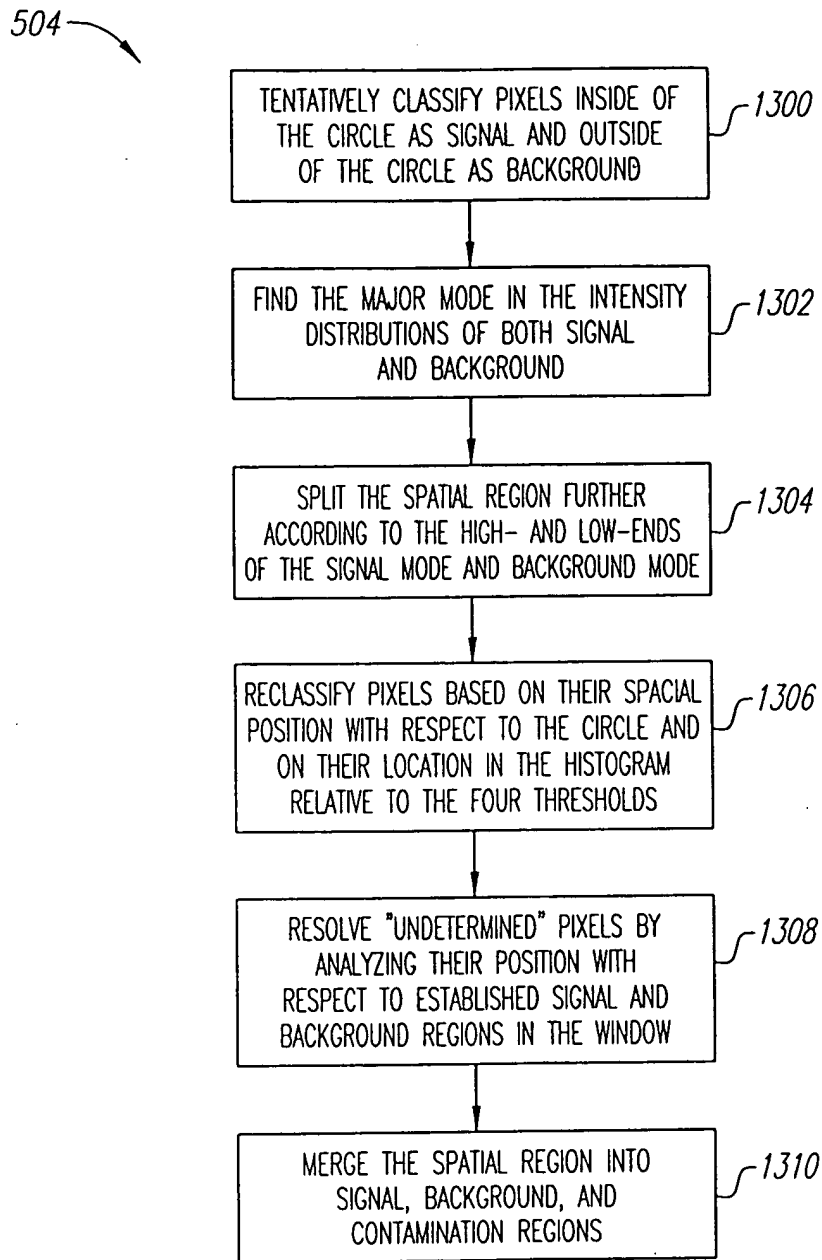

FIG. 11

**FIG. 12**

*FIG. 13*

1302

MAJOR MODE FINDING

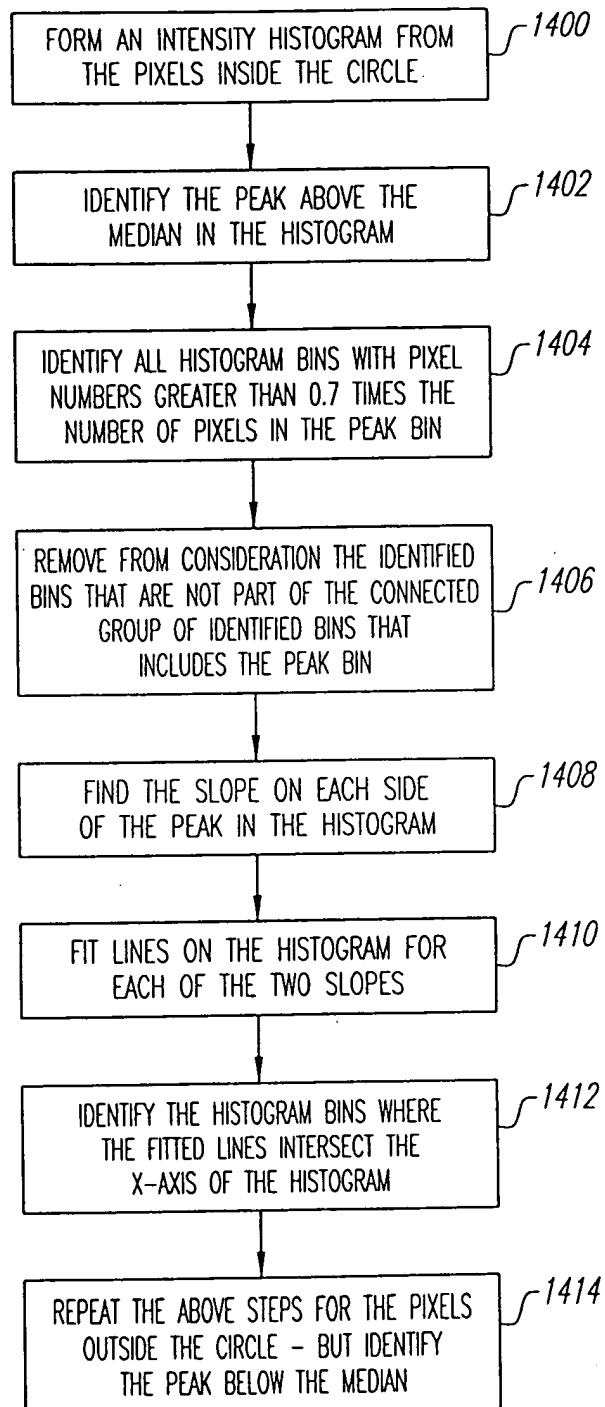

FIG. 14

SIGNAL HISTOGRAM

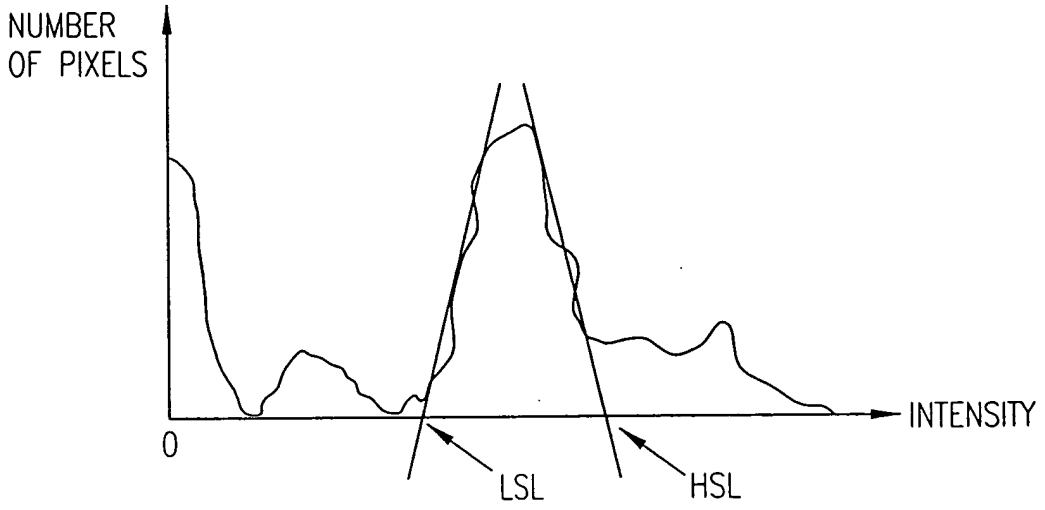

FIG. 15A

BACKGROUND HISTOGRAM

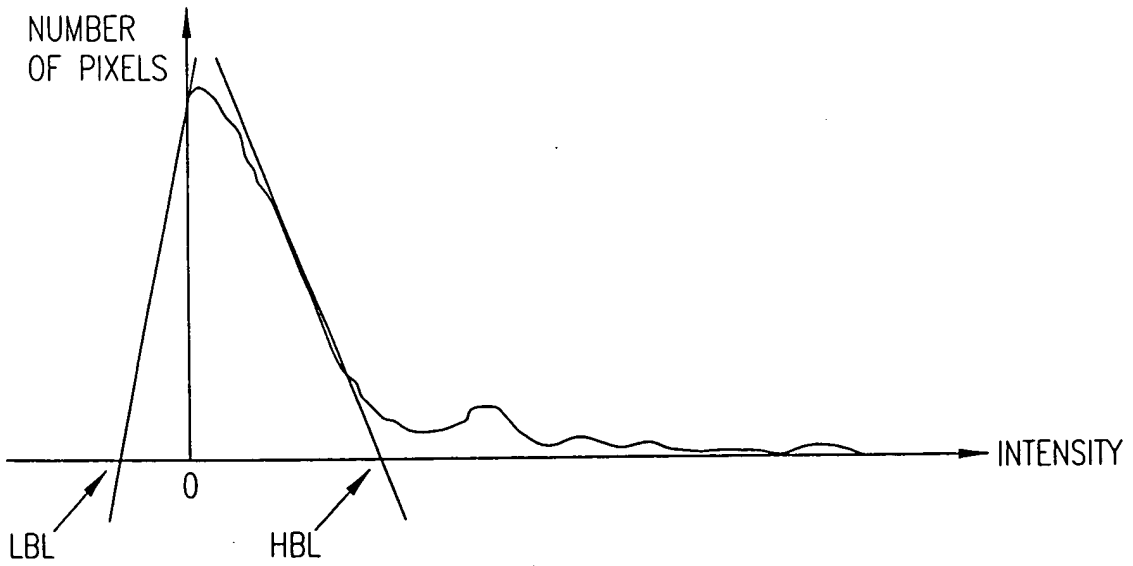

FIG. 15B

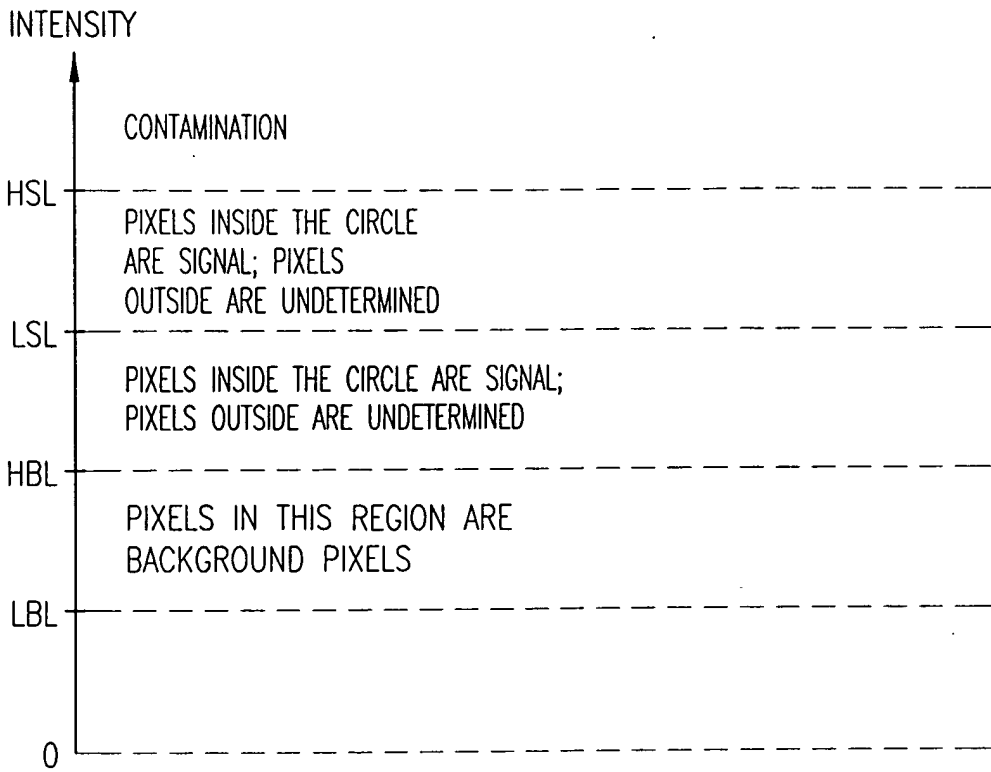

FIG. 16A

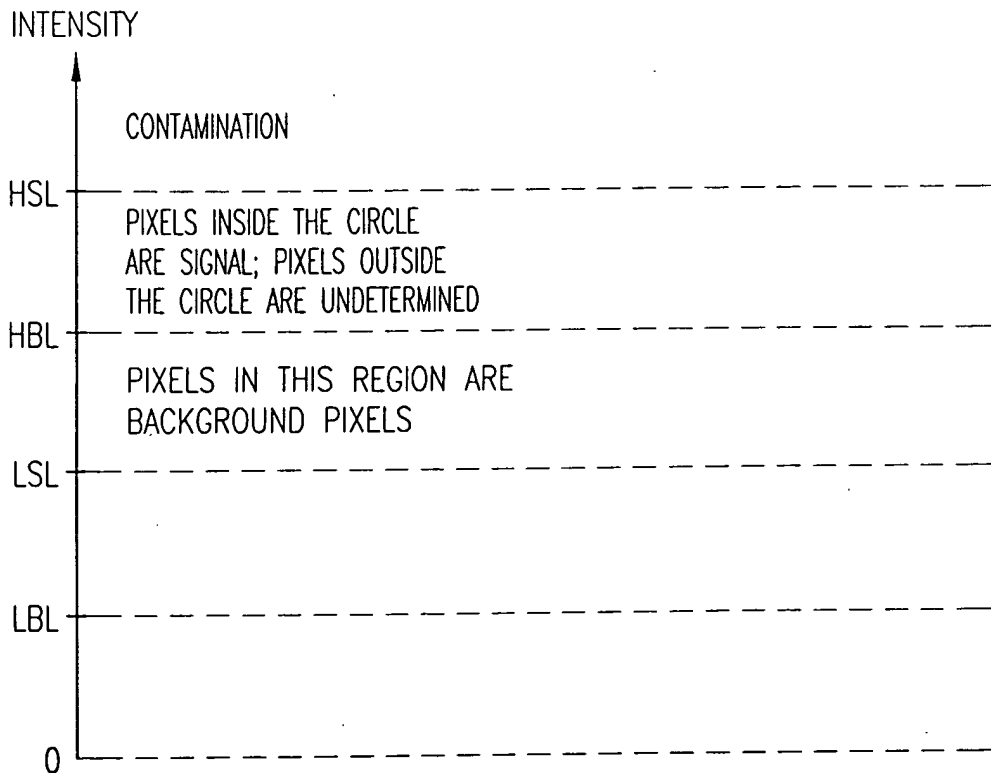

FIG. 16B

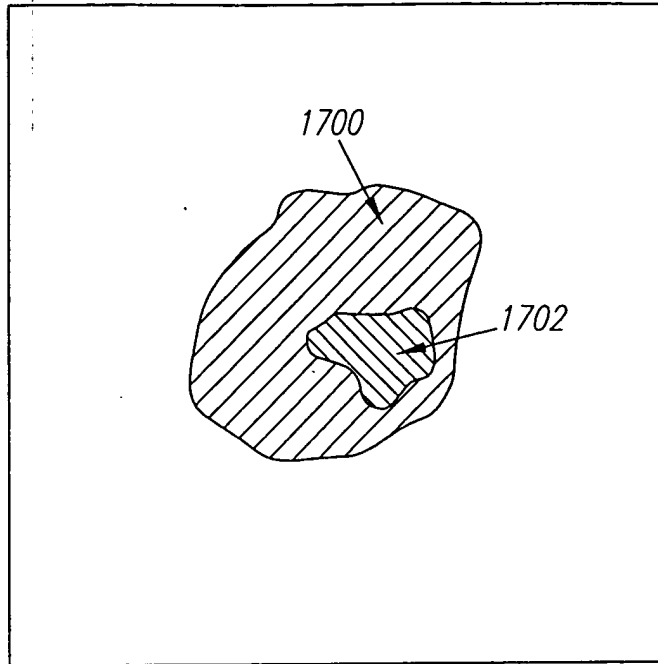

FIG. 17A

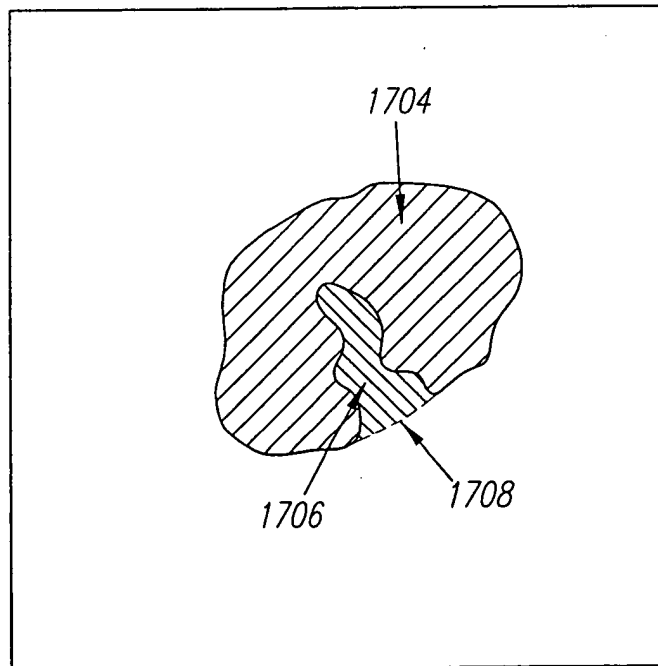

FIG. 17B